

Anode-support system for the direct electrorefining of cement copper

Part II: Process conditions using a circular cell with vertical rotary cathode

R. GANA*, M. FIGUEROA, L. KATTAN, I. MOLLER

Departamento Química Inorgánica, Facultad de Química, Pontificia Universidad Católica de Chile, Casilla 306 Correo 22. Santiago, Chile

M. A. ESTESO

Departamento Química-Física, Facultad de Farmacia, Universidad de La Laguna, Tenerife, España

Received 21 November 1994; revised 10 March 1995

This paper describes the second part of a study on the development of a modified anode-support system for the direct electrorefining of cement copper. The proposed system is an alternative process for small mines that produce cement copper after the leaching of copper oxide minerals. It is feasible to utilize a circular cell provided with an annular AISI-316 stainless steel mesh supporting a mass of cement copper as the anode system. A vertical rotary cylinder of AISI-316 stainless steel can be used as the cathode. The rotary cylinder, totally immersed in acidic copper sulphate electrolyte must have two isolated slots at the surface to permit the stripping of the copper deposits in the form of thin sheets. As operating conditions, a solution of $\text{CuSO}_4 \cdot 5\text{H}_2\text{O}$: 150 g dm^{-3} and H_2SO_4 : 50 g dm^{-3} , j_c : 5.0 A dm^{-2} , T : 40°C , u : 60 rpm, can be used. The cement copper must be maintained wet to avoid rapid oxidation. At this stage of the study cement copper of 90–95% purity was utilized.

1. Introduction

In the first part of this study [1] an electrochemical system for the direct electrorefining of cement has been proposed as an alternative process for small mines that produce cement copper after the leaching of copper oxide minerals [2–8]. In this process a modified type of ‘anode-support’ system (AS) developed and used by the authors to refine metals and to obtain different products was applied [9–15]. As the anode system, horizontal AISI-316 stainless steel mesh placed at the bottom of the cell and covered with a layer of cement copper was utilized. As the cathode system three horizontal rotary cylinders of AISI-316 stainless steel partially immersed in acidic copper sulphate electrolyte were used. The process resulted in copper deposits of good quality in the form of thin sheets which could be stripped from the cylinders. The main problem in the process was the formation of a nonconductive copper sulphate layer on the cement surface which gave rise to a strong anode overpotential resulting in a rapid increase in the cell voltage during the electrolysis. A pulsed current was used to minimize this problem.

To avoid the formation of the copper sulphate layer on the anode, in this paper a new electrochemical

alternative for refining cement copper using a circular cell is proposed. As cathode a vertical rotary AISI-316 stainless steel cylinder is utilized. The anode system comprises an annular support made of AISI-316 stainless steel mesh containing the cement copper. In the vertical anode system the anodic diffusion layer is thinner and less concentrated in cupric ions than in the corresponding horizontal system. Additionally, the anodic current density is smaller than the cathodic current density under normal operating conditions. As a consequence it was possible to run extended electrolyses maintaining constant the cell voltage without using pulsed current.

In this work a relatively pure cement copper was obtained by precipitation from a solution of technical grade copper sulphate. Aluminum scrap was used to precipitate the cement copper, thus avoiding contamination with iron.

2. Experimental details

Cement copper (90–95% Cu) was obtained by precipitation with aluminium scrap from a technical grade copper sulphate solution ($300\text{--}350 \text{ g dm}^{-3}$) acidified by sulphuric acid ($10\text{--}20 \text{ g dm}^{-3}$) at 60°C . The size fractions of copper particles were: $\sim 78\%$

* Author to whom correspondence should be addressed.

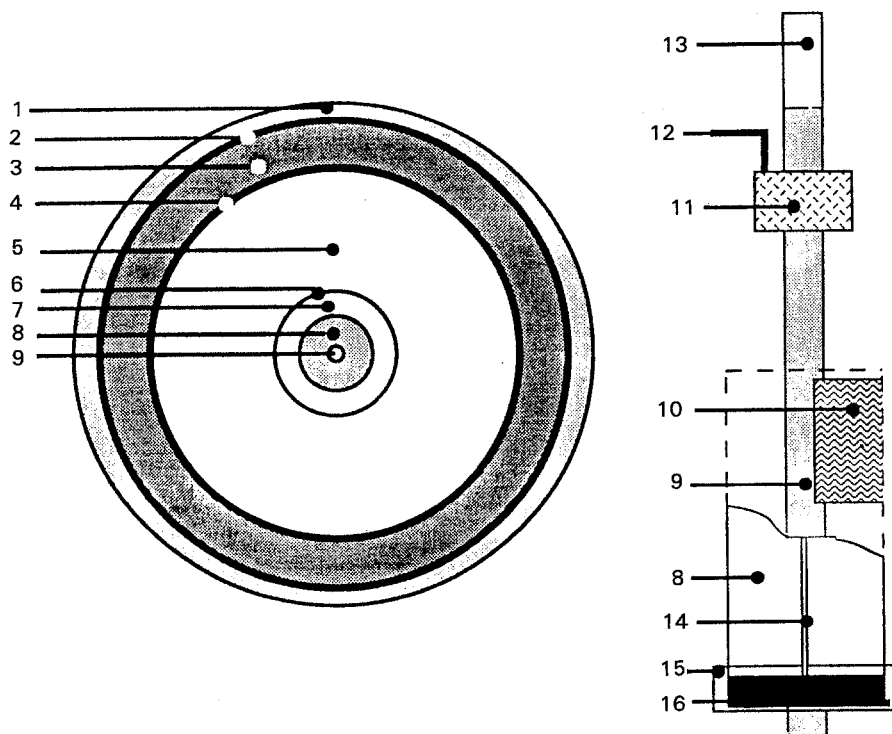

Fig. 1. Schematic design of the acrylic cell and rotary cathode: (1) acrylic cell, (2) copper sheet, (3) cement copper, (4) AISI-316 mesh, (5) anode compartment, (6) diaphragm, (7) cathode compartment, (8) rotary cathode (AISI-316), (9) copper shaft, (10) copper sheet contact, (11) cathodic contact (Hg), (12) copper wire, (13) Nylon shaft, (14) isolated slot, (15) acrylic screen and (16) rubber plug.

size $> 88 \mu\text{m}$ (Tyler mesh 170); $\sim 15\%$ size $< 88 \mu\text{m} > 53 \mu\text{m}$ (Tyler mesh 170 and 270); $\sim 7\%$ size $< 53 \mu\text{m} > 37 \mu\text{m}$ (Tyler mesh 270 and 400).

Electrolyses were carried out in a circular 3.5 dm^3 acrylic cell, having an interior diameter of 190 mm. The annular anode-support system was formed by an AISI-316 stainless steel mesh (diam. 160 mm), a sheet of copper (diam. 190 mm) and cement copper placed between the stainless steel and the copper sheet (Fig. 1). The copper sheet improved the electrical conductivity of the system, remaining protected by the cement copper during the electrolysis. As cathode system a vertical rotary AISI-316 stainless

steel cylinder, 50 mm diameter, 105 mm long and 1 mm thick was utilized. The anode/cathode area ratio was 3.2. The cylinder, totally immersed in the solution, had an internal electric contact via a 15 mm diameter copper shaft. Two acrylic screens of 65 mm diameter were placed at both ends of the cylinder to avoid the production of dendritic deposits on the edges of the rotary cathode. Two 1 mm wide slots at the cylinder surface, filled with epoxy resin, allowed the stripping of the copper deposits.

An annular diaphragm of polypropylene 3016 (Reicotex-Chile) with an air permeability of $26 \text{ dm}^3 \text{ dm}^{-2} \text{ min}^{-1}$, was utilized to separate the cathode and anode compartments. The working volume of the solution was increased by means of an external 7.5 dm^3 glass column of 100 mm diameter to permit decantation of fine cement copper

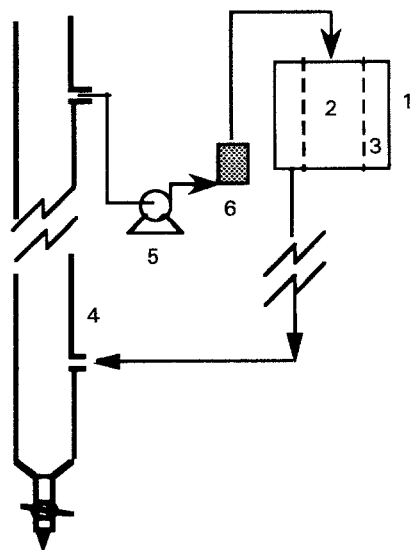

Fig. 2. Schematic diagram of the system with continuous filtration: (1) cell, (2) cathode compartment, (3) anode compartment, (4) column, (5) peristaltic pump and (6) filter.

Table 1. Electrolyte and operating parameters studied in the direct electrorefining of cement copper

<i>Electrolyte</i>	
$\text{CuSO}_4 \cdot 5\text{H}_2\text{O}$	$50\text{--}200 \text{ g dm}^{-3}$
H_2SO_4	$50\text{--}200 \text{ g dm}^{-3}$
<i>Electrodes</i>	
Anode-support mesh	AISI-316 stainless steel
Cathode cylinder	AISI-316 stainless steel
<i>Operating parameters</i>	
Anode area	5.1 dm^2
Cathode area	1.6 dm^2
j_a/j_c	3.2
Temperature	$20\text{--}40 \text{ }^\circ\text{C}$
Rotation speed	10–200 rpm
Diaphragm	polypropylene

particles dispersed in the anolyte (Fig. 2). The solution was continuously sucked from the bottom of the anode compartment, decanted in the column, filtered and returned to the cathode compartment. The recirculation and filtration of the electrolyte was provided by a Cole-Parmer peristaltic pump (7015 head) and a polypropylene filter tube (Sethco, porosity $15\ \mu\text{m}$). The rotation of the cylinder (10–200 rpm) was achieved by means of a variable speed stirrer IKA RW-18. The electrolyte composition and the operating parameters are given in Table 1.

3. Results and discussion

3.1. Current density

Figure 3 shows the effect of the cathodic current density on the cell voltage, after 8 h electrolyses, with and without cathode rotation speed (30 rpm). In the range j_c (cathode current density): 2–6 A dm^{-2} , the voltage variation is practically linear. A more favourable result was achieved with cathode rotation because in that case the mass transport process was mainly controlled by convection. No passivation of the cement copper mass was observed with j_a (anode current density): 0.6–1.9 A dm^{-2} .

3.2. Cathode rotation speed

To determine the influence of the cathode rotation speed on the cell voltage, 1 h electrolyses with rotations between 30 and 200 rpm were run in the j_c range 2 to 6 A dm^{-2} .

Figure 4 indicates that, in the range studied, there was no difference in the voltage values when the cathode rotation speed was increased. Nevertheless, better copper crystallization was achieved when the

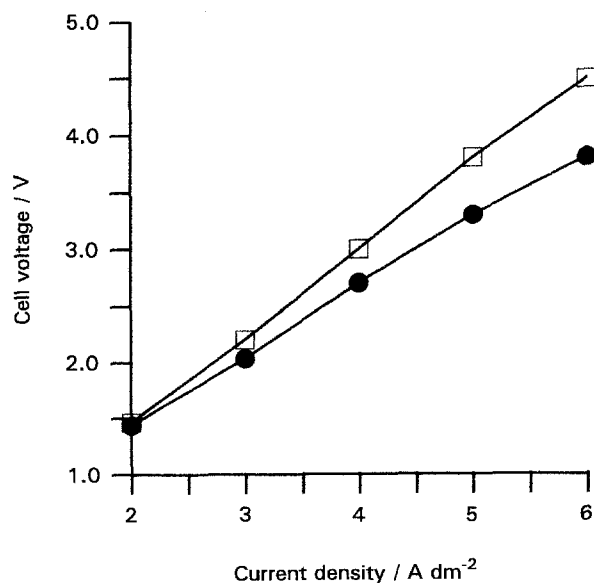

Fig. 3. Effect of the cathodic current density on the cell voltage. Electrolyte $\text{CuSO}_4 \cdot 5\text{H}_2\text{O}$: $150\ \text{g dm}^{-3}$, H_2SO_4 : $50\ \text{g dm}^{-3}$, at $20 \pm 1^\circ\text{C}$. Key: (\square) u : 0 rpm and (\bullet) u : 30 rpm.

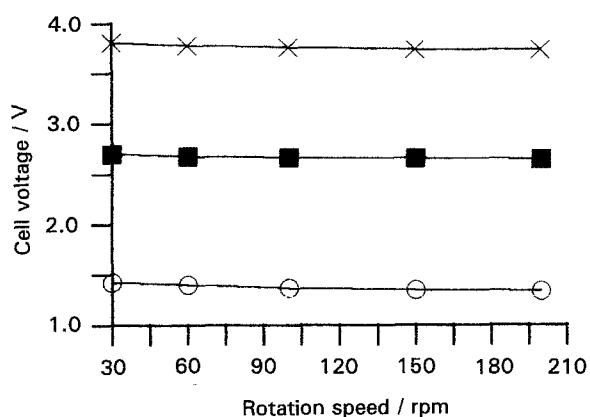

Fig. 4. Cell voltage variation as a function of cathode rotation speed. Electrolyte $\text{CuSO}_4 \cdot 5\text{H}_2\text{O}$: $150\ \text{g dm}^{-3}$, H_2SO_4 : $50\ \text{g dm}^{-3}$, at $20 \pm 1^\circ\text{C}$. Current density, j_c : (\circ) 2, (\blacksquare) 4 and (\times) 6 A dm^{-2} .

rotation speed was maintained between 60 to 100 rpm. When a higher speed was used, the electrolyte agitation was violent and many small cement particles passed through the diaphragm from the anolyte to the catholyte generating poor quality copper deposits with nodular and dendritic growth.

3.3. Temperature

Figure 5 shows the effect of temperature on the cell voltage, when 2 h electrolyses were carried out with two cathode rotation speeds, maintaining the current density constant. The voltage variation was as expected and can be explained by a change in the electrolyte conductivity. In the range 20–40 $^\circ\text{C}$ the rotation speed had no influence on the cell voltage. When the temperature was lower than 20 $^\circ\text{C}$, the mass transport was insufficient to maintain the copper ion concentration near the cathode and in that case the higher speed had a favourable effect. Under the indicated operating conditions the system reached a practically constant temperature

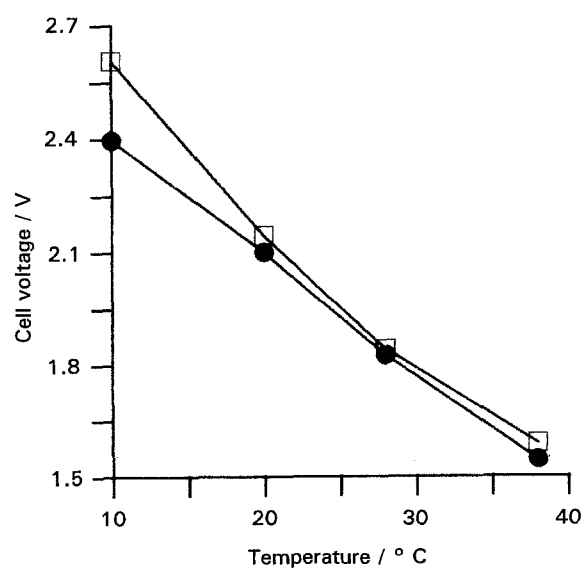

Fig. 5. Cell voltage variation as a function of temperature. Electrolyte $\text{CuSO}_4 \cdot 5\text{H}_2\text{O}$: $150\ \text{g dm}^{-3}$, H_2SO_4 : $50\ \text{g dm}^{-3}$, j_c : 3 A dm^{-2} , 2 h electrolyses. Rotation speed, u : (\square) 60 and (\bullet) 110 rpm.

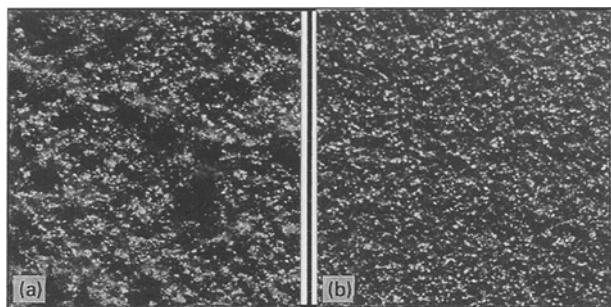

Fig. 6. Effect of electrolyte filtration on the quality of the copper deposits ($40\times$). Electrolyte $\text{CuSO}_4 \cdot 5\text{H}_2\text{O}$: 150 g dm^{-3} , H_2SO_4 : 50 g dm^{-3} , j_c : 5 A dm^{-2} , T : $40 \pm 1^\circ\text{C}$, u : 60 rpm , 8 h electrolyses. (a) Without filtration and (b) with filtration.

of $40 \pm 3^\circ\text{C}$ after 2–3 h of electrolysis (Joule effect). At 40°C good quality copper deposits were obtained, better than the deposits achieved at lower temperature.

3.4. Filtration

Figure 6 shows the nature of the copper sheets obtained with and without recirculation and filtration of the solution. Deposits with many nodules were obtained when electrolyses were run without filtration (a). A good crystallization of copper was obtained when the electrolyte was filtered (b), with neither nodular nor dendritic growth on the deposits. The filtered solution was returned to the cathode compartment and so a continuous hydrostatic pressure was exerted by the catholyte on the diaphragm, avoiding the passage of fine particles from the anode to the cathode compartments.

3.5. Cathode screens

The effect of two annular acrylic screens placed at both ends of the rotary cathode was very favourable. Figure 7 shows that when 8 h electrolyses were run without the use of screens (Fig. 6(a)) a poor quality copper deposit was obtained, with many dendrites. When the cylinder edges were protected by the screens a dense compact copper deposit was obtained (Fig. 6(b)).

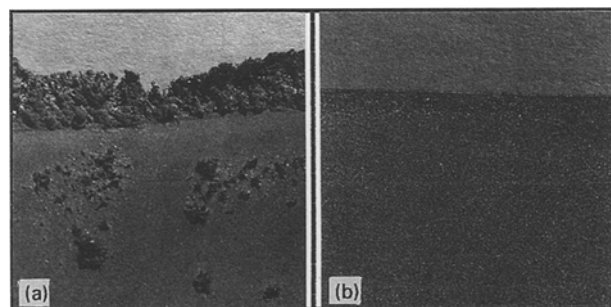

Fig. 7. Effect of the use of cathodic screens on the quality of the copper deposits ($2\times$). Electrolyte $\text{CuSO}_4 \cdot 5\text{H}_2\text{O}$: 150 g dm^{-3} , H_2SO_4 : 50 g dm^{-3} , j_c : 5 A dm^{-2} , T : $40 \pm 1^\circ\text{C}$, u : 60 rpm , 8 h electrolyses. (a) Without screens and (b) with screens.

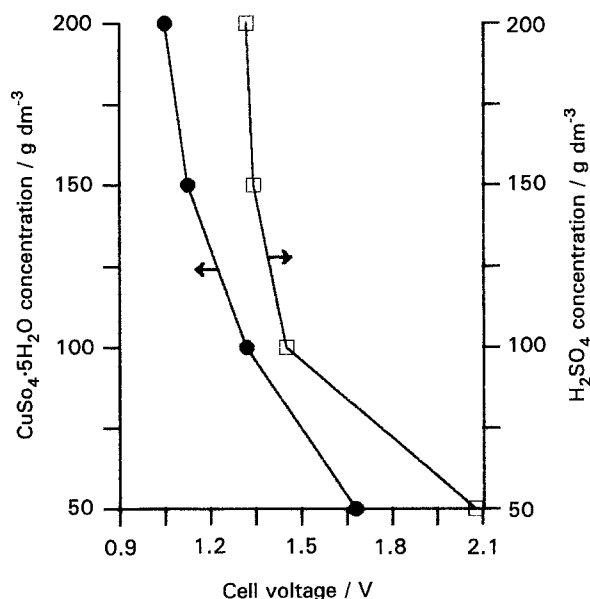

Fig. 8. Effect of copper sulphate and sulphuric acid concentrations on the cell voltage. j_c : 3 A dm^{-2} , T : $40 \pm 1^\circ\text{C}$, u : 60 rpm , 30 min electrolyses. (●) $\text{CuSO}_4 \cdot 5\text{H}_2\text{O}$ conc. and (□) H_2SO_4 conc.

3.6. Electrolyte concentration

Figure 8 indicates the influence of the sulphuric acid and copper sulphate concentrations on the cell voltage. In this system, to obtain a good quality of copper deposit, it was advisable to maintain the copper sulphate concentration higher than 100 g dm^{-3} . The cell voltage was reduced 35% by increasing the sulphuric acid concentration from 50 to 200 g dm^{-3} . Nevertheless, when the acid concentration was higher than 100 g dm^{-3} and the electrolysis was run at high current density, it was possible to form a nonconducting layer of copper sulphate on the cement copper due to the sulphate ion effect. For this reason, when experiments of longer duration were carried out, electrolyte solutions of $\text{CuSO}_4 \cdot 5\text{H}_2\text{O}$: $100\text{--}150 \text{ g dm}^{-3}$ and H_2SO_4 : $50\text{--}100 \text{ g dm}^{-3}$ were used.

The concentration change at the end of a 50 h electrolysis (375 A h) was an increase of $2.9 \times 10^{-2} \text{ g (Ah)}^{-1}$ for cupric ion and a decrease of $14.6 \times 10^{-2} \text{ g (Ah)}^{-1}$ for sulphuric acid, with a molar ratio variation $\text{H}_2\text{SO}_4/\text{Cu}^{2+}$ equal to 5.0, higher than the theoretical value 1.0. This behaviour is related to the consumption of acid by reaction with the oxide copper contained in the cement copper and the general copper corrosion of the particulated copper mass ($\text{Cu} + 2\text{H}^+ + 1/2\text{O}_2 \rightarrow \text{Cu}^{2+} + \text{H}_2\text{O}$).

3.7. Long duration experiment

Figure 9 shows the variation of the cell voltage with time, when a 50 h electrolysis was run with j_c : 5 A dm^{-2} , reloading the anode-support with cement copper each 16 h. With the proposed system it was possible to run the experiment without any problems caused by anode passivation. A cell voltage fluctuation of 10% was observed, with a slight decrease after

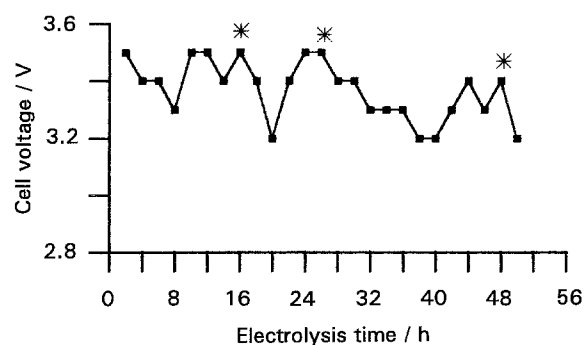

Fig. 9. Variation of cell voltage with time in a 50 h electrolysis. Electrolyte $\text{CuSO}_4 \cdot 5\text{H}_2\text{O}$: 150 g dm^{-3} , H_2SO_4 : 50 g dm^{-3} , j_c : 5 A dm^{-2} , T : $40 \pm 1^\circ\text{C}$, u : 60 rpm. (*) Cement copper reloading.

the cement additions. Good quality copper sheets (>99.98%) more than 3 mm in thickness were obtained.

3.8. Corrosion of AISI-316 stainless steel

To detect any possible attack on the stainless steel, four 700–800 mg samples of the AISI-316 stainless steel used in the AS system were connected electrically outside the annular mesh. After a total of 735 Ah, a weight loss in the range 0.02–0.04% was observed, without any relation to the location of the samples. No pitting corrosion of the samples could be seen under an optical microscope ($60\times$).

Nevertheless, it should be noted that in this study a good quality cement copper free of chlorides, iron and other impurities was used. In further work the behaviour of the same system loaded with industrial cement copper will be studied.

4. Conclusions

In this work the feasibility of using a vertical rotary cathode in a circular cell with an annular anode-support system for electrorefining cement copper (90–95% purity) was studied. When an electrolysis was carried out, the anode-support made of AISI-316 stainless steel remained passive, acting only as an electrical contact between the cement copper and the external current source.

It was possible to obtain copper deposits of good quality (>99.98%) in the form of thin sheets (3 mm thick) which could be easily stripped from the AISI-316 rotary cathode.

In this circular cell the formation of a nonconductive

copper sulphate layer on the cement copper was avoided [1].

The concentration of copper sulphate increased and the amount of sulphuric acid decreased continuously when the electrolysis was carried out. For this reason, in long duration electrolyses (e.g. 50 h) it is necessary to return part of the solution to the cementation process or to utilize an electro-winning cell for maintaining the copper and sulphuric acid concentrations in the desired range.

The following are the most important operating conditions in the process: $\text{CuSO}_4 \cdot 5\text{H}_2\text{O}$ 100–150 g dm^{-3} , H_2SO_4 50–100 g dm^{-3} , cathodic current density 5 A dm^{-2} , temperature 40°C , cathode rotation speed 200 rpm, using continuous electrolyte filtration and cathode screens.

Acknowledgements

The authors are grateful for support from the Fondo Nacional de Desarrollo Científico y Tecnológico (FONDECYT) and from the Dirección de Investigación de la Pontificia Universidad Católica de Chile (DIUC).

References

- [1] R. Gana, M. Figueroa, L. Kattan, J. M. Sánchez and M. A. Esteso, *J. Appl. Electrochem.* **25** (1995) 240.
- [2] Technical Report, Codelco Chile, *Min. Chil.*, no. 129 (1992) 21.
- [3] K. Jarufe, *Min. Chil.*, no. 94 (1989) 79.
- [4] G. Ugarte, *Min. Chil.* no. 59 (1985) 37.
- [5] A. K. Biswas and W. G. Davenport, 'Extractive metallurgy of copper', Pergamon, Oxford (1976) chapters 13 and 14.
- [6] C. K. Gupta and T. K. Mukherjee, 'Hydrometallurgy in extraction processes', vol. 1, CRC Press, Boston (1990).
- [7] C. K. Gupta and T. K. Mukherjee, 'Hydrometallurgy in extraction processes', vol. II, CRC Press, Boston (1990).
- [8] E. Domic, *J. Met.*, Jan. (1984) 48.
- [9] R. Gana, M. Figueroa *et al.*, *Chilean Patents* 31.280 (1980), 31.869 (1980), 32.091 (1981), 32.144 (1981), 33.877 (1983), 35.010 (1985), 35.011 (1985).
- [10] R. Gana, M. Figueroa, L. Kattan and S. Castro, *J. Appl. Electrochem.* **23** (1993) 813.
- [11] M. Figueroa, R. Gana, L. Kattan and A. Parodi, *ibid.* **24** (1994) 206.
- [12] R. Gana, M. Figueroa, L. Kattan and J. M. Orpinas, *ibid.* **23** (1993) 60.
- [13] M. Figueroa, R. Gana, W. C. Copper and J. Ji, *ibid.* **23** (1993) 308.
- [14] R. Gana, M. Figueroa, A. Aragón, M. T. San Martín and L. Kattan, *ibid.* **24** (1994) 542.
- [15] R. Gana, M. Figueroa, V. Arancibia and J. Solis, *ibid.* **24** (1994) 1146.